

Project:		Submitted by:	
Qty:		Type:	
Product Number:		Date:	

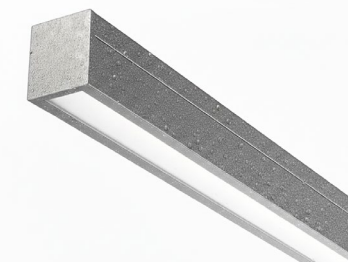

Acculine WL offers a robust IP66/IK11-rated linear LED lighting system engineered for wet-location and demanding environments.

Features

- ▶ 2" / 3" / 4" profiles
- ▶ Quick connect wiring option
- ▶ Illuminated joiners
- ▶ Suspended, surface, recessed and wall mounting
- ▶ Low-glare baffle available
- ▶ Sensor / control options

Sizes

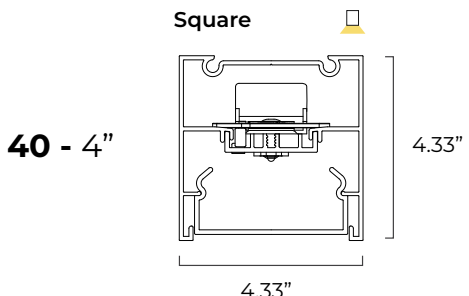
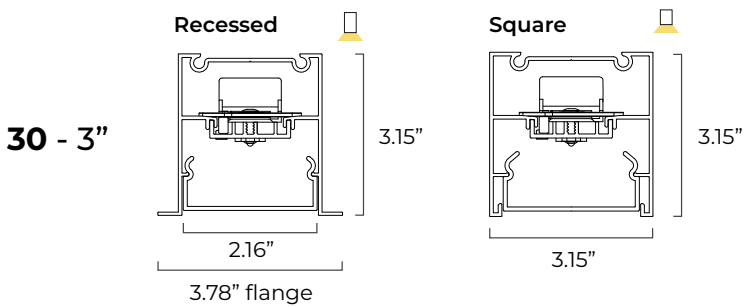
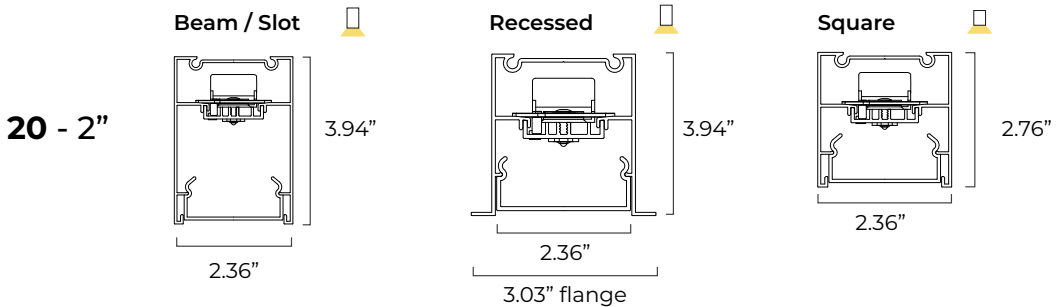

7 / 10 / 15* Warranty
Year / Year / Year

*10 year and 15 year warranty options available - may impact pricing/lead times.



Project:			Submitted by:	
Qty:		Type:		
Product Number:			Date:	

Specifications

SIZES	SHAPES:	IP RATING	LIGHT DISTRIBUTION	DIFFUSER / OPTICS
Nominal Profile widths: 2 inch 3 inch 4 inch	<ul style="list-style-type: none"> • Square • Slot • Recessed 	IP66 Outdoor covered use	<ul style="list-style-type: none"> • Direct (standard) • Direct-Asymmetric 	<ul style="list-style-type: none"> • Polycarbonate • Glass

Nominal Profile lengths:

- 2ft = 600 mm
- 3ft = 900 mm
- 4ft = 1200mm
- 5ft = 1800mm
- 8ft = 2400mm

CCT	CRI	DRIVER	DIMMING	ELECTRICAL	OUTPUT
<ul style="list-style-type: none"> • 3000k • 3500k • 4000k 	80 CRI standard	<ul style="list-style-type: none"> • Non dimming fixed output • 0-10V dimming • Casambi wireless • DALI • DMX 	Standard: ON/OFF Optional:* 0-10V DALI	6 - 14 W/ft PF > 0.9 THD < 9.8% Voltage <ul style="list-style-type: none"> • 120-277 Universal • 347 Canada 	<ul style="list-style-type: none"> • 500 lm/ft • 750 lm/ft • 1000 lm/ft *Custom lumen outputs available upon request

LIFETIME	EFFICACY
7 years, 82k hours Operating Temp: -13°F to 140°F (-25°C to 50°C) (No direct sunlight)	70 - 85 Lm/W (depending on options and finishes)

FINISH	MOUNTING	ACCESSORY OPTIONS	HOUSING
Aluminium extrusion with powder-coated finish: Standard powder-coated colors are: <ul style="list-style-type: none"> • Textured White • Textured Black • Silver Pearl • Clear Anodized Custom powder-coat on request: <ul style="list-style-type: none"> • Custom Color RAL • Custom Color Anodized 	<ul style="list-style-type: none"> • Wire Suspension • Rod Suspension • Recessed Flange • Wall Block • Flush Mount 	<ul style="list-style-type: none"> • Integral Emergency • Sensor • Canopy Plate • Remote Driver 	Extruded aluminum with powder coated finish. End Caps: <ul style="list-style-type: none"> • Standard • Screw-less

JOINER OPTIONS:	CONNECTIONS:
Lit corner 90° / Cross 90° / T 90° / Straight 180° Join	Fast connecting joining system with polarized electrical connection between sections

CERTIFICATION:	WARRANTY:
UL Listed IP66 IK11	Standard: 7 Year limited warranty. Optional: 10 or 15 Year limited warranty. (available with qualifying specifications and installation conditions)

*Custom options may affect pricing and lead times. Contact PAL for more information.



Project:		Submitted by:	
Qty:		Type:	
Product Number:		Date:	

Ordering

ORDERING EXAMPLE: AW-30-BE-66-D-PC-40-80-A1-U-500-TB-WS-ET-6

1: FORM

SERIES	SIZE	SHAPE	IP RATING
AW			66
AW Acculine Wet Loc.	20 2 inches	BE* Beam	IP66 rated outdoor
	30 3 inches	SQ square	*No direct sunlight.
	40 4 inches	SQH** square HO	
		SL* Slot	
		RE* recessed	
		* NOT AVAILABLE AL-40 **NOT AVAILABLE AL-20 & AL-30	

2: OPTICS

DISTRIBUTION	DOWNWARD - DIFFUSER/OPTICS	CCT
D		
D Direct	PC Polycarbonate	30 3000k
	GL Glass	35 3500k
		40 4000k
		CRI
		80
		80 80 CRI standard

3: ELECTRICAL

DRIVER	VOLTAGE	OUTPUT*
ND non dimming fixed output	U 120-277 Universal	500 500 lumens
A1 0-10v dimming	3 347 Canada	750 750 lumens
CS casambi wireless		1000 1000 lumens
DA Dali		— Custom lumen *Delivered Lumens

4: FINISH

HOUSING FINISH
TW Textured White
TB Textured Black
SV Silver Pearl
CA* Clear Anodized
C* — Custom Color RAL
CC* — Custom Color Anodized
*Additional option available upon request — consult factory.

5: MOUNTING

MOUNTING
WS Wire Suspension
RD Rod Suspension
RE* Recessed
WB Wall Block
CE Ceiling Mount
FM Flush Mount
RF* Recessed Flange
*Recessed (RE) SHAPE only.

6: OPTIONS

OPTIONS
ET Integral Emergency
DL Downlight
SN Sensor
CN Canopy Plate
SE Screwless endplate
RM Remote driver
ASY Asymmetric Distribution
BF Back Feed
TF Top Feed
EF End Feed
Add all options that apply.

7: LENGTH

NOMINAL LENGTHS*
2 2ft (600 mm)
3 3ft (900 mm)
4 4ft (1200mm)
6 5ft (1800mm)
8 8ft (2400mm)
—* Custom Length in ft
*Custom lengths can be specified to fit standard lengths OR to the inch. Specifying to the inch will be subject to additional lead time and costs.



Project:		Submitted by:	
Qty:		Type:	
Product Number:		Date:	

Joining Options

Joiners

(only available for PC / PG diffusers.
Unless advised, joiners will be illuminated, match finish, and match light distribution.)

Custom Patterns

(Describe the requested form/pattern -
ex. "1 square, approx. 4' in width")



AL L90
"L" joiner, 90°







AL T90
"T" joiner, 90°



AL X90
"X" joiner, 90°

Colors

Standard Colors

-  Textured White
-  Textured Black
-  Silver Pearl
-  Clear Anodized

Additional Colors / Finishes (Extra Cost)







- RAL Colors
- Rust / Timbers
- Anodized
- Concrete Finishes
- Non-Standard Colors

For a full color
swatch chart,
click or scan the
QR code

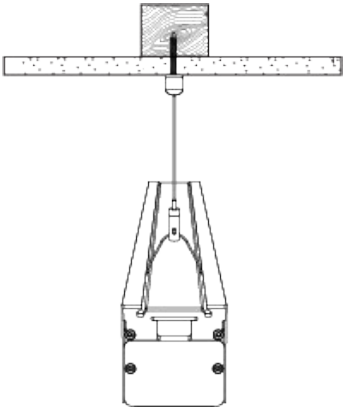
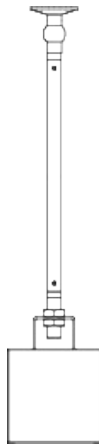
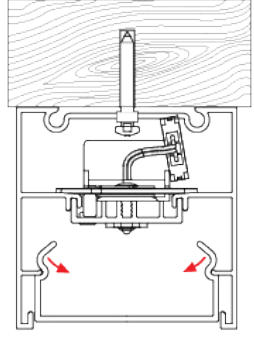

Project:		Submitted by:	
Qty:		Type:	
Product Number:		Date:	

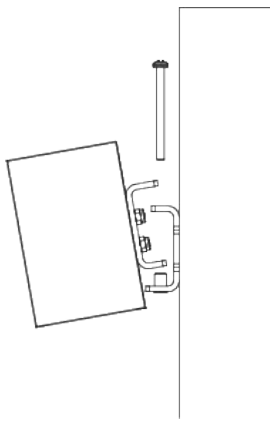
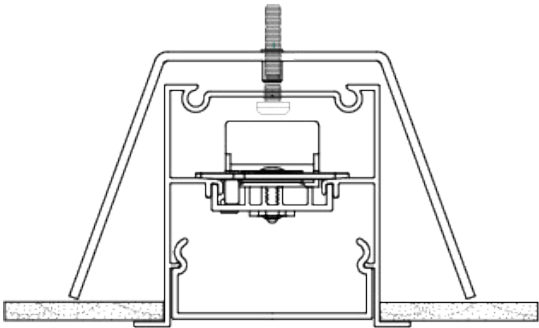
Mounting

 <p data-bbox="235 913 503 955">Wire Suspension</p>	 <p data-bbox="722 913 950 955">Rod Suspension</p>	 <p data-bbox="1201 913 1421 955">Surface Mount</p>
<p data-bbox="251 1018 414 1102">Instructions Click or scan the QR code</p> 	<p data-bbox="738 1018 901 1102">Instructions Click or scan the QR code</p> 	<p data-bbox="1209 1018 1372 1102">Instructions Click or scan the QR code</p> 
 <p data-bbox="349 1669 544 1711">Wall Bracket</p>	 <p data-bbox="1120 1669 1258 1711">Recessed</p>	
<p data-bbox="495 1774 657 1858">Instructions Click or scan the QR code</p> 	<p data-bbox="1209 1774 1372 1858">Instructions Click or scan the QR code</p> 	



Project:		Submitted by:	
Qty:		Type:	
Product Number:		Date:	

Lengths

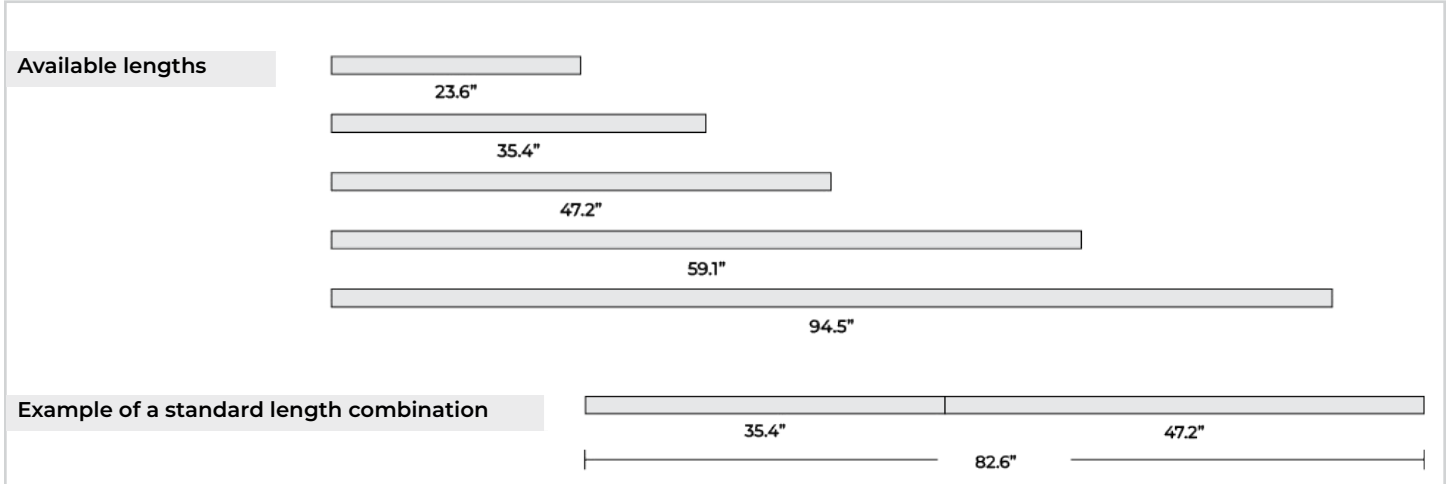

Joining Configurations

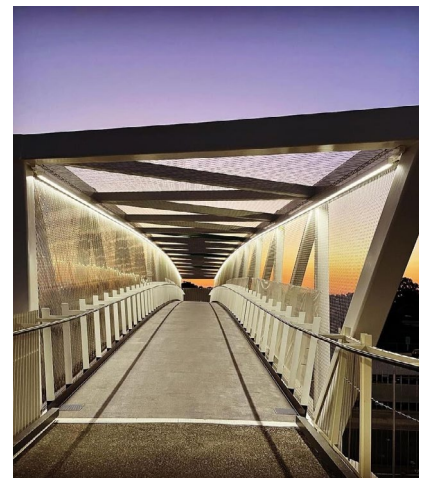
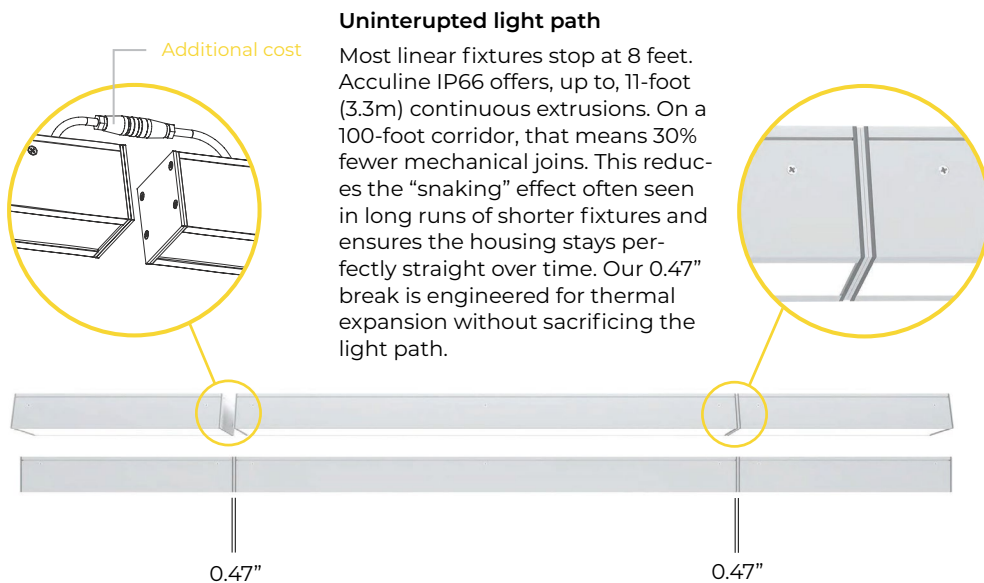

Suggested "Architectural Significance" text in specification:

Uninterrupted Architectural Continuity:

The Acculine IP66 Series utilizes extended 11-foot (3378mm) single-piece aluminum extrusions to minimize visible vertical seams in long-run applications. Combined with a precision 0.47" joint and a continuous ribbon diffuser, the Acculine IP66 delivers a consistent lumen package across the entire run, eliminating the 'socket-shadow' common in modular linear systems. Designed for high-traffic commercial environments, the IK11 impact rating and IP66 sealing ensure architectural intent is preserved in the most demanding conditions.

Project:		Submitted by:	
Qty:		Type:	
Product Number:		Date:	

Optics

Diffuser options:

Optical control (Downward Diffuser)



Polycarbonate



Glass



Louvre Powdercoated
White / Black / Silver

Diffuser definitions:

Polycarbonate: A diffused, impact-resistant lens that delivers soft, uniform illumination with excellent durability.

Louvres: A directional grid optic that minimises glare and spill light by shielding the light source and guiding the beam.

