

# SURFACE MOUNT

## INSTALLATION INSTRUCTIONS

- 1 Support structure
- 2 Fastner
- 3 Power Connection
- 4 Profile
- 5 Gear Tray
- 6 Diffuser

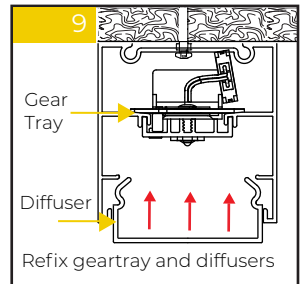
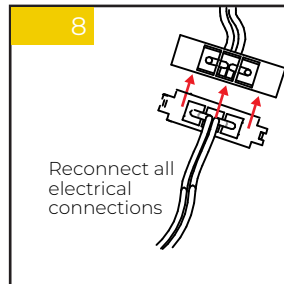
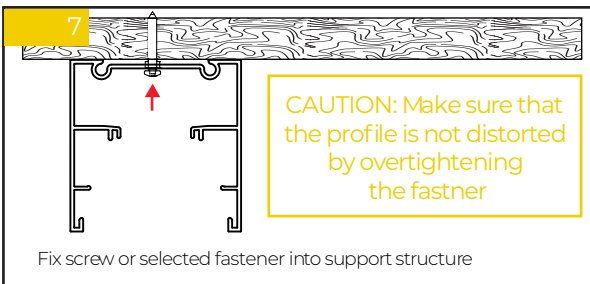
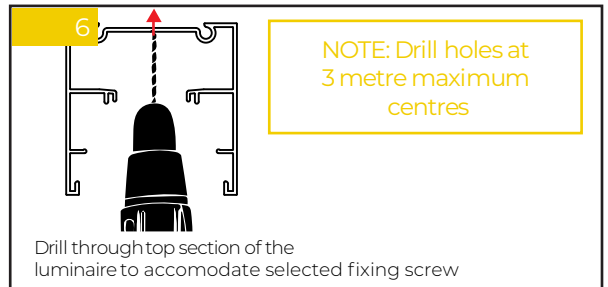
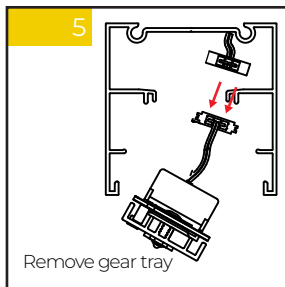
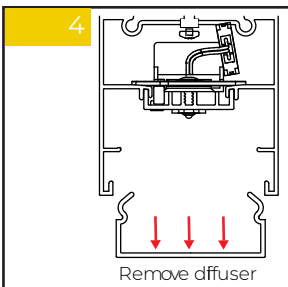
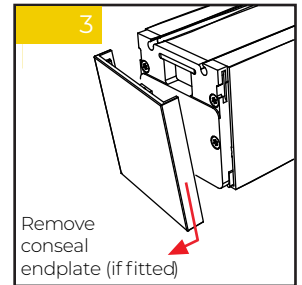
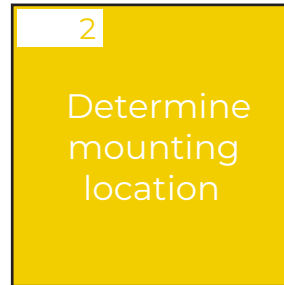
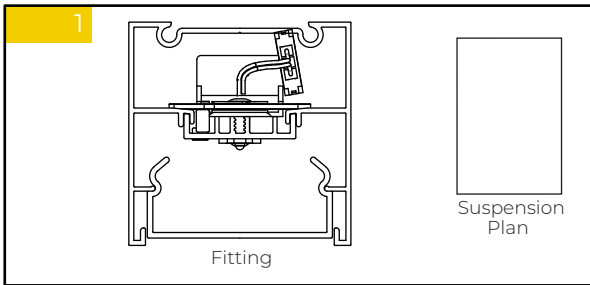
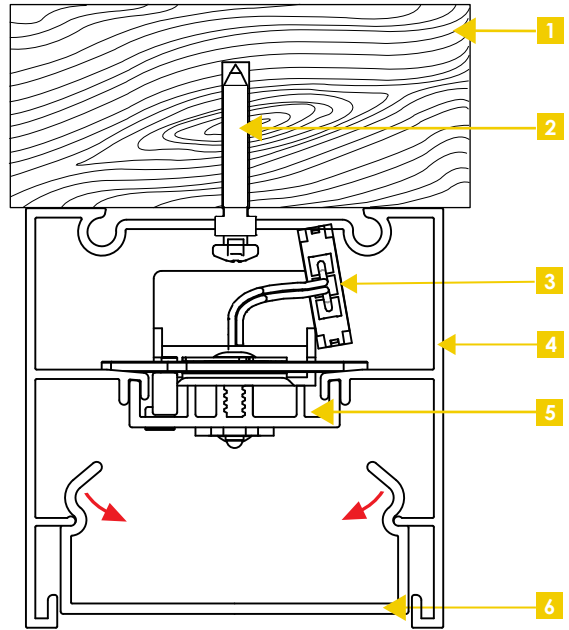

For more information, please contact you local representative by visiting <https://pal-lighting.com/company/contact/>  
4830 Timber Creek Drive, Houston, Texas 77017  
(713) 946-4343