

Report of Test

LLIA001329-012

Integrating Sphere Report

Catalog Number: PS5-A-MO-K35-80-4-XX-WTR-LOH-XXXV

Recessed mounted, extruded aluminum housing, formed white enamel aluminum LED tray, translucent white plastic enclosure.

144 white LEDs, two Osram PrevaLED Bars with 72 LEDs each.

One Osram Optotronic OTI 20/120-277/700 DIM-1 L G2LED driver labeled as 480mA

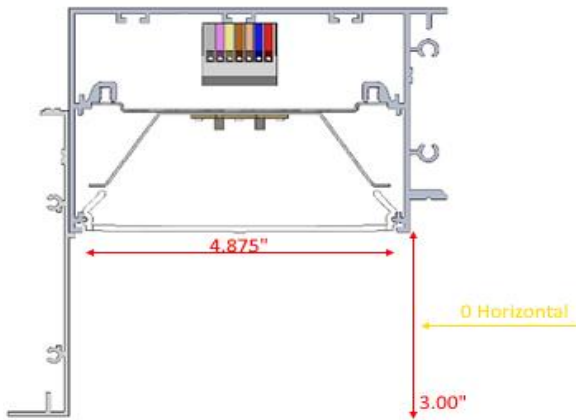

Performance Summary

Voltage	277.0 Vac
Current	0.0719 A
Power	18.90 W
Frequency	59.97 Hz
Power Factor	0.949
Current THD	7.8 %
Total Luminous Flux	2070.9 lm
Efficacy	109.6 lm/W
Chromaticity (x,y)	(0.4043, 0.3862)
(u',v')	(0.2369, 0.5092)
Duv	-0.0018
CCT	3485 K
CRI (Ra)	84
R9	16
TM-30: Rf	83
TM-30: Rg	96

Prepared For:

Precision Architectural Lighting
4830 Timber Creek Drive
Houston, TX 77017, USA

Test date: 10/12/2020
Report date: 10/14/2020

Signed: _____

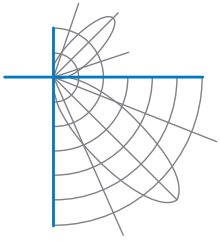

Test Report Number: LLIA001329-012

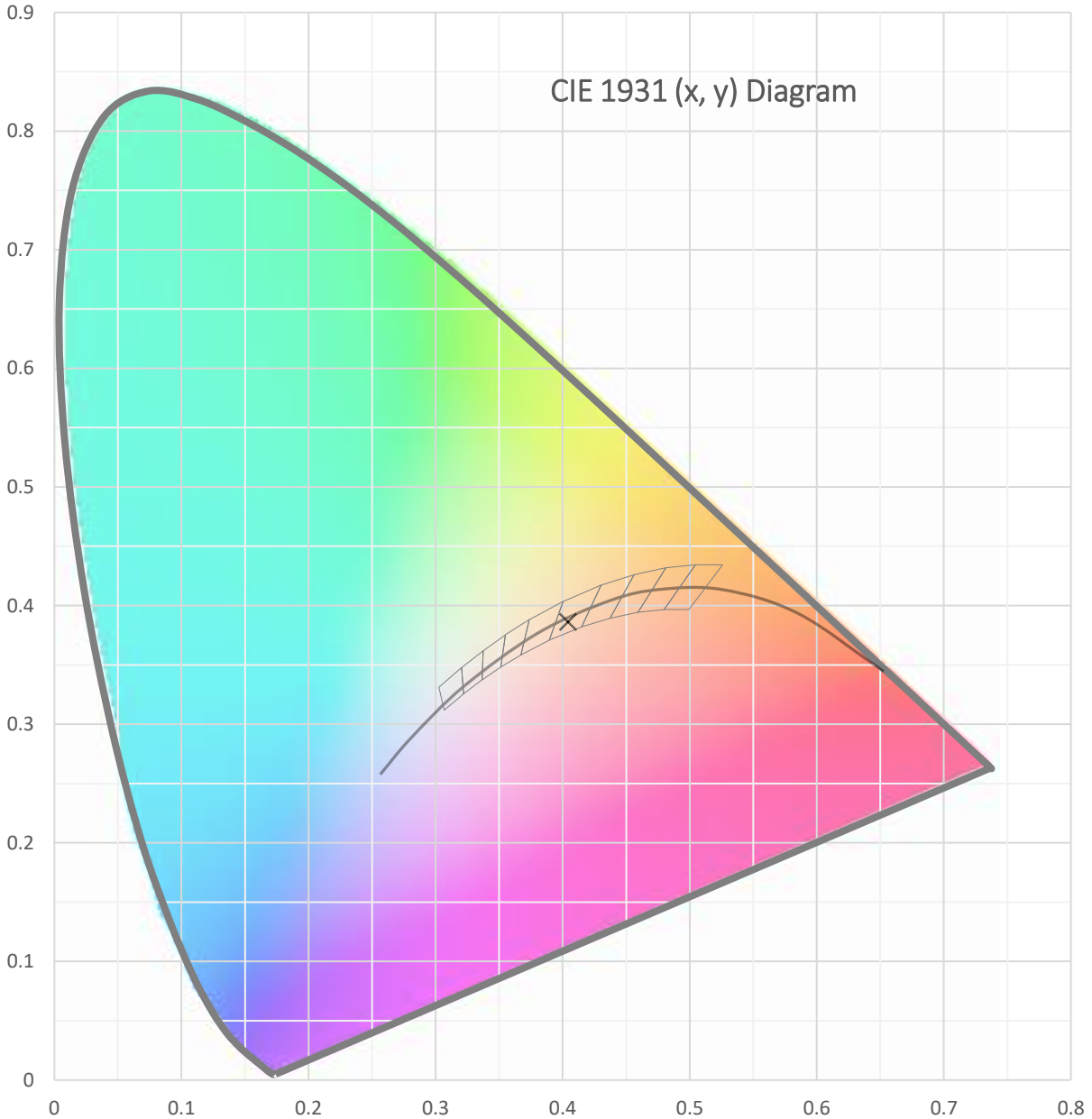

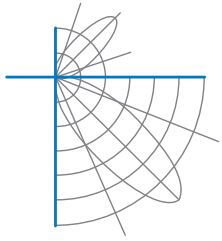

Test Report Number: LLIA001329-012

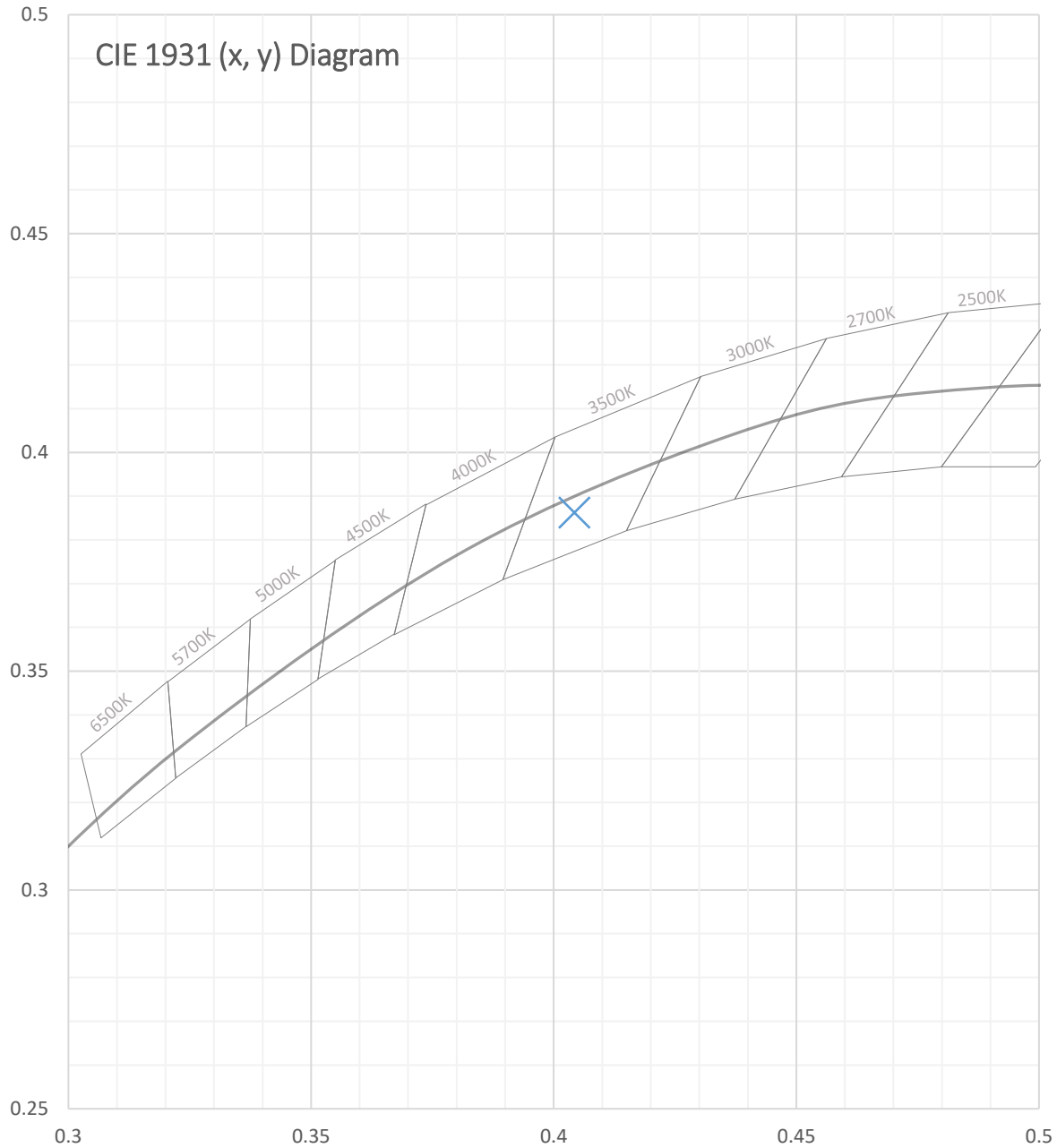

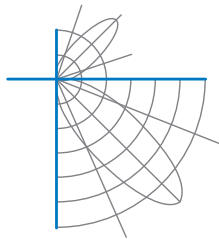

Test Report Number: LLIA001329-012

Total Radiant Flux	6.449 W
Total Luminous Flux	2070.9 Lm
Chromaticity CIE 1931 (x, y)	(0.4043, 0.3862)
Chromaticity CIE 1976 (u', v')	(0.2369, 0.5092)
Correlated Color Temperature (CCT)	3485 K
Color Rendering Index (Ra)	84
R1	83
R2	91
R3	96
R4	83
R5	83
R6	88
R7	85
R8	65
R9	16
R10	79
R11	82
R12	67
R13	85
R14	98
TM-30: Rf	83
TM-30: Rg	96
Distance from Planckian Locus (Duv)	-0.0018
Scotopic/Photopic Ratio ‡	1.542

Electrical Data

Voltage	277.0 Vac
Current	0.0719 A
Power	18.90 W
Frequency	59.97 Hz
Power Factor	0.949
Current THD	7.8 %



Test Report Number: LLIA001329-012

Summary Spectral Power Distribution (wavelength - nm, spectral power - W/nm)

380	0.000279	480	0.009177	580	0.035408	680	0.010921
385	0.000299	485	0.009912	585	0.036612	685	0.009516
390	0.000361	490	0.011149	590	0.037694	690	0.008249
395	0.000463	495	0.013052	595	0.038270	695	0.007118
400	0.000590	500	0.015324	600	0.038581	700	0.006154
405	0.000709	505	0.017396	605	0.038310	705	0.005284
410	0.000840	510	0.019087	610	0.037543	710	0.004521
415	0.001021	515	0.020528	615	0.036382	715	0.003891
420	0.001395	520	0.021682	620	0.034767	720	0.003334
425	0.002153	525	0.022590	625	0.033040	725	0.002849
430	0.003646	530	0.023542	630	0.031154	730	0.002435
435	0.006378	535	0.024312	635	0.029106	735	0.002077
440	0.011165	540	0.025230	640	0.026954	740	0.001777
445	0.021419	545	0.026269	645	0.024793	745	0.001526
450	0.034895	550	0.027391	650	0.022588	750	0.001307
455	0.033303	555	0.028594	655	0.020350	755	0.001121
460	0.021345	560	0.029848	660	0.018268	760	0.000968
465	0.016769	565	0.031216	665	0.016131	765	0.000833
470	0.013415	570	0.032648	670	0.014222	770	0.000711
475	0.009914	575	0.034004	675	0.012504	775	0.000614
						780	0.000528

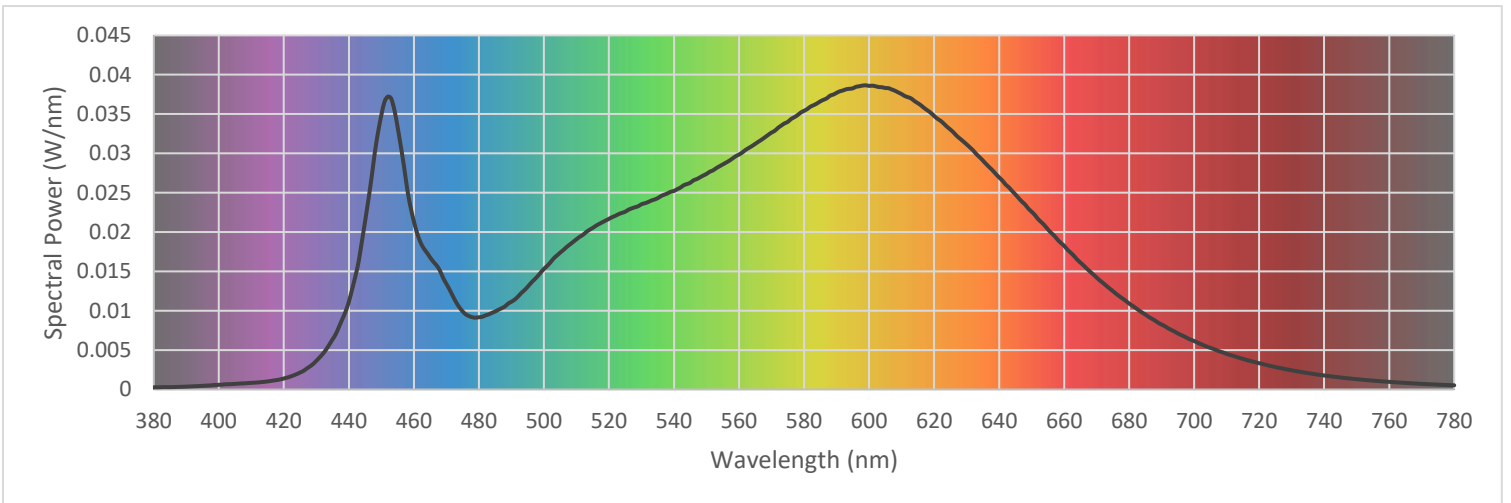

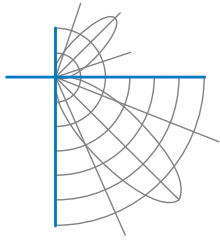

Test Report Number: LLIA001329-012

IES TM-30 Details

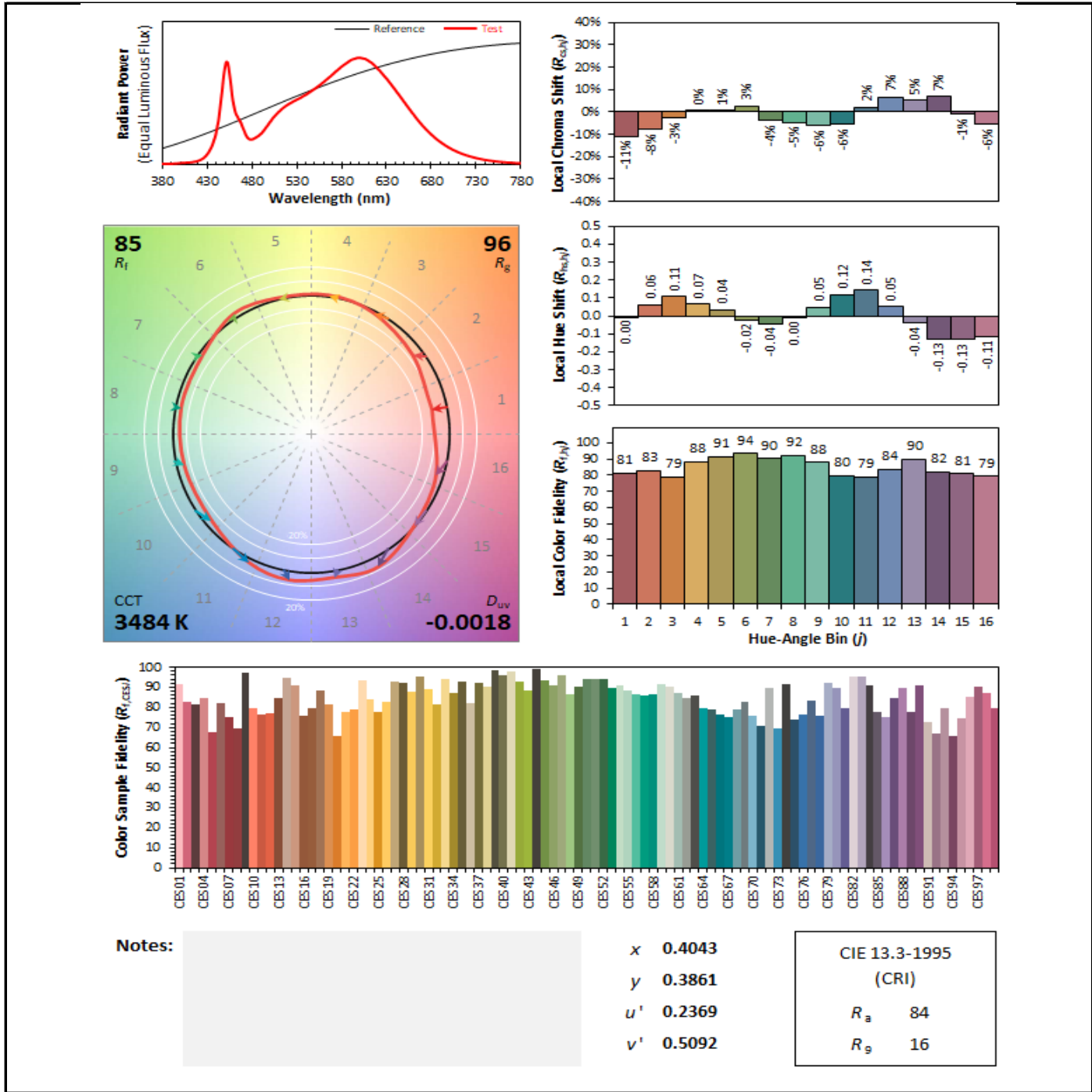



Test Report Number: LLIA001329-012

Test Equipment Configuration: LightLab International Allentown 2m Integrating Sphere
Measurements acquired using a Labsphere CDS 2600 spectroradiometer
Testing was performed using 4 π geometry

Test Temperature: 24.7 °C

Test Procedure: Tested in accordance with the applicable sections of:
LM-79-19, LM-78-07, LM-58-13, ANSI_ANSI C78.377-2017, TM-30-18

Significance: The laboratory has not participated in the selection of samples to be tested.
All testing is performed on the understanding that the significance of the report is limited to the extent that the test sample is representative of production units.

Notes: The measurements and other derived quantities contained in this report are based on the absolute data as measured.

Prorating the performance of the sample for the use of other component combinations (such as lamp / LED / Ballast / driver), or for use in different environmental conditions than that tested, may produce erroneous results.

This report is free of erasures and corrections

This report may contain data that are not covered by the NVLAP accreditation. Quantities marked with ‡ are not covered.

This report must not be used by the customer to claim product certification, approval or endorsement by NVLAP, NIST, or any agency of the Federal Government.