

Catalog Number	Type
Project Name	

# Delgada-LED Series

## Connector Specifications

### S P E C I F I C A T I O N S

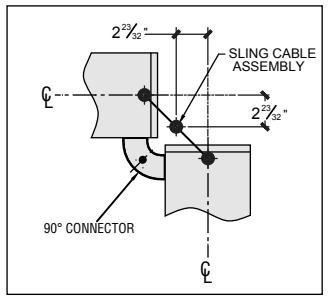

DCS – CURVED 90° CONNECTOR

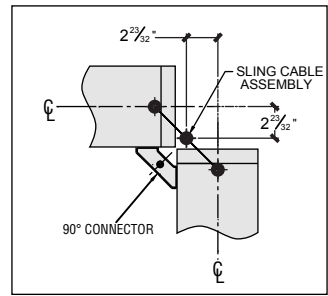

DRS – RECTANGULAR 90° CONNECTOR

**Delgada Series Fixture Dimensions**

- Curved Housing (DCS)** 7 5/8" x 2"
- Rectangular Housing (DRS)** 7 5/16" x 2"

**Construction** One piece die-cast aluminum.

**Finish** Standard and premium finishes are baked powder coat electrostatically applied (2.0 mil. minimum thickness) to assure aesthetics and durability.

### H O W T O O R D E R

Standard Connectors are 2-way 90°

**Catalog Logic**

All connectors should be specified and ordered as follows:

Sample Catalog Number: **DCS - L90 - CN - F01M**

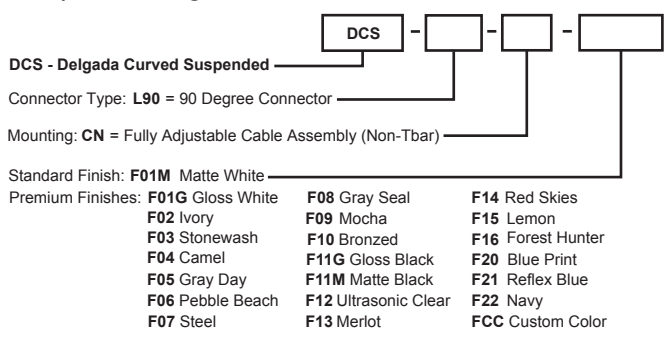

Sample Catalog Number: **DRS - L90 - CN - F01M**

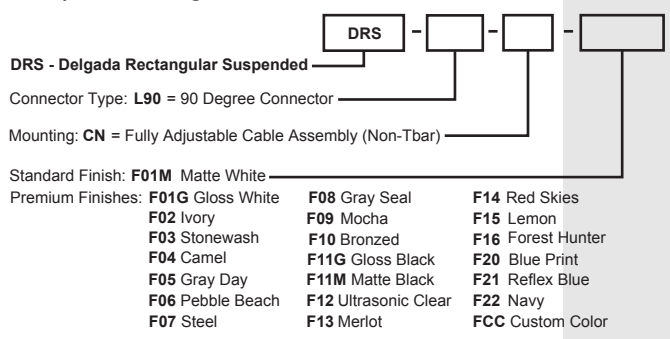

# Delgada-LED Series

## Standard Fixture Lengths and Mounting Centers Cable Mount - Indirect/Direct Configurations

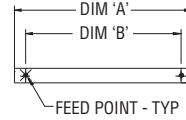
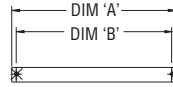
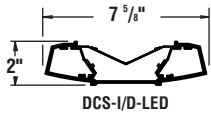

FLAT END OPTION

DCS	MOUNTING CENTERS	DRS
FIXTURE LENGTH	DIM 'B'	FIXTURE LENGTH
DIM 'A'	DIM 'B'	DIM 'A'
49 1/4"	48"	50 1/2"
97 1/4"	96"	98 1/2"

EXTENDED END OPTION

DCS	MOUNTING CENTERS	DRS
FIXTURE LENGTH	DIM 'B'	FIXTURE LENGTH
DIM 'A'	DIM 'B'	DIM 'A'
57"	48"	57"
105"	96"	105"

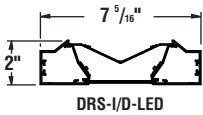

## Wall Mount - Indirect/Direct Configurations

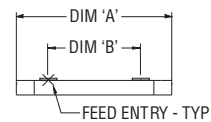
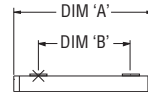
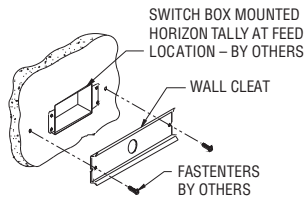
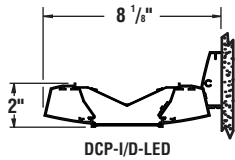

FLAT END OPTION

DCP	MOUNTING CENTERS	DRP
FIXTURE LENGTH	DIM 'B'	FIXTURE LENGTH
DIM 'A'	DIM 'B'	DIM 'A'
49 1/4"	36"	50 1/2"
97 1/4"	84"	98 1/2"

EXTENDED END OPTION

DCP	MOUNTING CENTERS	DRP
FIXTURE LENGTH	DIM 'B'	FIXTURE LENGTH
DIM 'A'	DIM 'B'	DIM 'A'
57"	36"	57"
105"	84"	105"

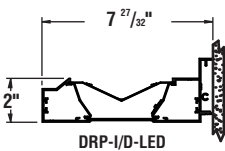
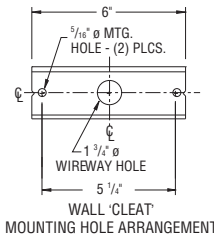

PAL RESERVES THE RIGHT TO CHANGE PRODUCT DESIGN AND SPECIFICATIONS. CONTACT FACTORY FOR MOST RECENT PRODUCT INFORMATION.

